

CONTROL TIPS

A ROBERTSHAW® INFORMATIONAL GUIDE

THIS ISSUE

INFINITE CONTROL SWITCHES BACKGROUND - OPERATION - TROUBLESHOOTING

The Robertshaw® Controls Company has manufactured over 250,000,000 infinite controls. These switches are used widely for top burners on electric ranges. Because of their unique design, they have also been used in a variety of other applications and manufactured in many voltages, mounting and dial stem variations.

Infinite switch controls and the 5500 Series Universal Infinite Uni-Kits are distributed for easy replacement of original equipment infinite controls. In addition, many brand specific Uni-Kits are available for replacement application needs.

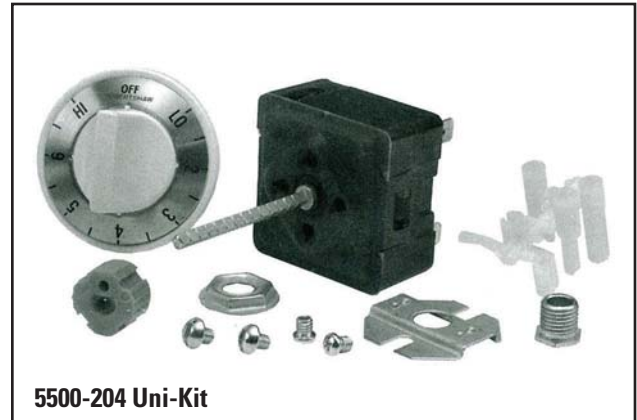

5500-204 Uni-Kit

5500 Series Universal Infinite Uni-Kits include adapters for screw or palnut type mounting. Uni-Kits are available with white dials, black dials or no dial and include a variety of dial adapters to allow the original equipment dial to be used. Uni-Kits have a patented, factory assembled dial shaft with easy break off grooves which can be snapped off to match various shaft lengths. Models are rated 15 amps at 120V AC, 208V AC and 240V AC resistive load. Infinite switches should not be applied where the ambient temperatures exceed 180°F. Complete specification, ordering information and cross reference data can be located in the Uni-Line Catalog. The Uni-Line Catalog is available online at www.invensyscontrols.com or you can obtain a printed copy from Sales or Customer Service. Installation instructions with a variety of wiring diagrams (including replacement of other brand infinite switches) are included with each Uni-Kit.

How the Model INF Infinite Control Operates

The dial shaft of the Model INF turns clockwise or counterclockwise. It is equipped with three positive indexing positions: Hi-Off-Lo. In the Hi position, the Model INF control is energized continuously. At other settings it delivers the selected level of input under the control of a bimetal timer. A double-line disconnect is provided when the INF control is in the Off position. If the shaft does not turn easily, press down slightly on the knob as some Model INF controls include a Push-to-Turn safety feature. The permanent magnet provides for a snap action of the contacts (see diagram on page 2).

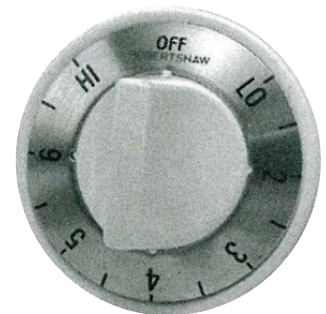

The Model INF control contains a bimetal which regulates the running cycles. This bimetal has a resistance wire wrapped around it which is connected in parallel with the heating unit being controlled and is cycled in unison with the heating element. When the dial is turned to any On position, the cam follower moves out and allows the cycling contacts to close. This completes a circuit through the heating unit

being controlled, as well as the circuit to the resistance wire wrapped around the bimetal. At this time the steel armature is under the influence of the pull from the magnet. As the resistance wire heats the bimetal, the bimetal flexes and forces are built up in it. When the force built up is equal to the magnetic pull of the magnet, the cycling contacts open with a snap action and the steel armature will be pulled away from the magnetic field which will cutoff the power of the heating unit being controlled and will also disconnect the power to the bimetal resistance wire. As the bimetal cools, it will then flex in the opposite direction and the contacts will start moving closer together. At a certain point the magnetic pull will close with a snap action. This will permit current to flow throughout the unit once again as the circuit is complete. Any time the Model INF is in an On condition, both the Manual Switch Blade contact and the Pilot Light Blade circuit are made. Use of a pilot light is not required for the INF control to operate. A second bimetal is employed as an ambient temperature compensator to neutralize the effect of the surrounding temperatures on the control bimetal.

Model INF controls are designed to operate in locations where the maximum ambient temperature does not exceed approximately 180°F. They are position sensitive and the top is clearly marked on the back of the housing. The Model INF can control any resistive load up to 15 amps. It is possible to obtain a range of inputs to the element and/or load from approximately 5% or 22-1/2% at Lo, depending on model, to 100% at Hi, and infinite settings in between.

Looking at the terminal connections on the back of the Model INF control, L1 and L2 represent power connections at the incoming source. H1 and H2 are the load connections that are connected to the load. P is for a pilot light attachment that is not required for the device to function.

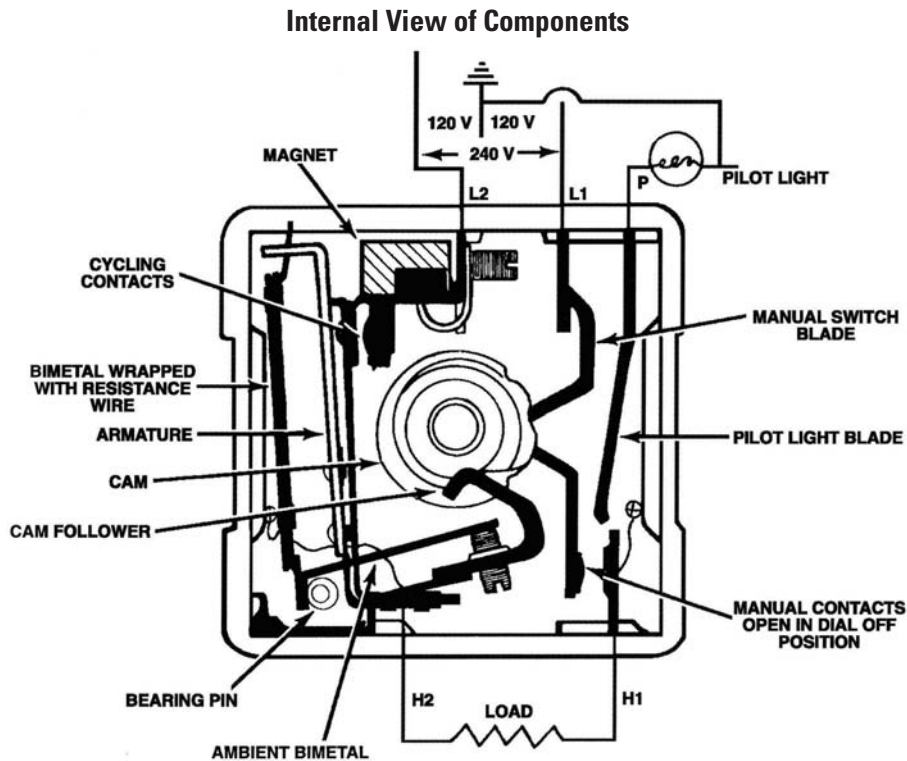

UL LISTING – COMMERCIAL AND DOMESTIC MODELS

Model INF controls are recognized under the component program of Underwriters Laboratories, Inc. as: Temperature - Indicating and Regulating Equipment
 UL FILE #E12103

Troubleshooting Model INF Infinite Controls

CAUTION: This device should be installed and tested by a qualified service technician with due regard for safety and code requirements. High electrical voltages may be present during testing and care should be exercised.

Continuity Tests

Turn off electrical power and disconnect all wires from the infinite control.

Set the dial in the Hi position. With a proper test meter set for the Ohms scale (RX1) there should be continuity between terminals L1 and H1 (Figure 1), L2 and H2 (Figure 2), and between P (pilot circuit) and H1 (Figure 3).

The control is defective if there is no continuity present in any one of the checks.

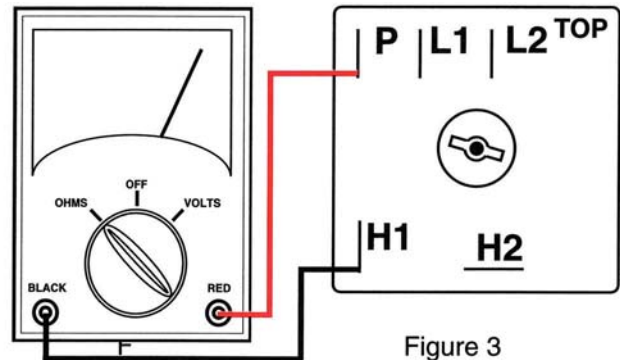
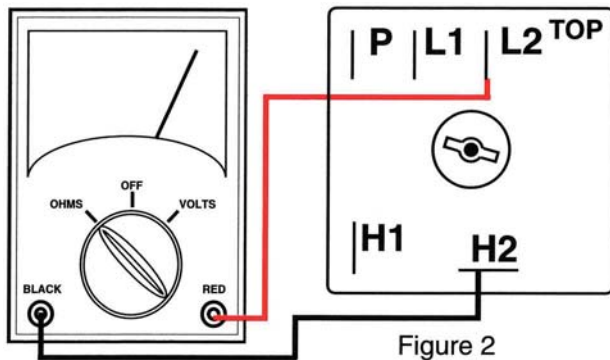
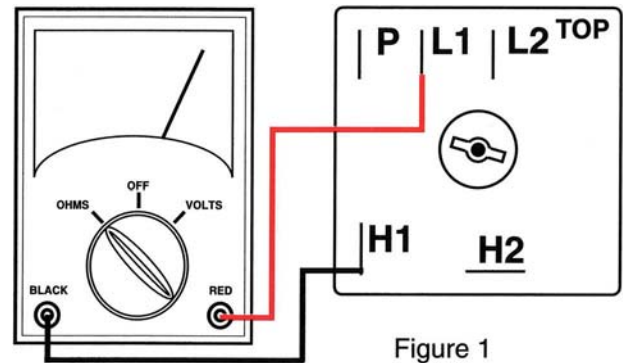

Electrical Tests

With power to the appliance and the infinite control in the Off position (wires connected), set the test meter to a voltage scale (approximately 240 volts or higher) and place the leads on terminals L1 and L2. If the switch is a 240 volt model, approximately 240V should be read (Figure 4). If power is not observed, check the appliance wiring and retest.

With power to the appliance and the infinite control turned to the Hi position, place the voltmeter leads on terminals H1 and H2. Approximately 240V should be read. If 240V is not present, then replace the infinite control (Figure 5).

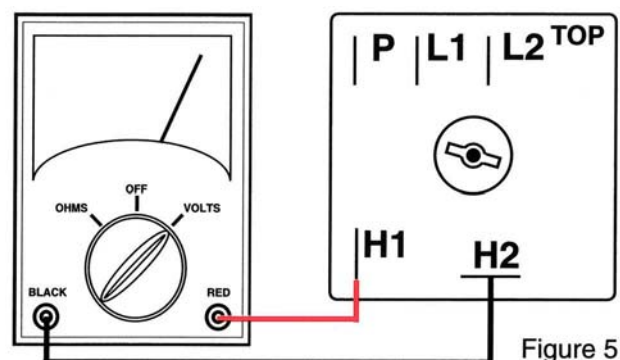
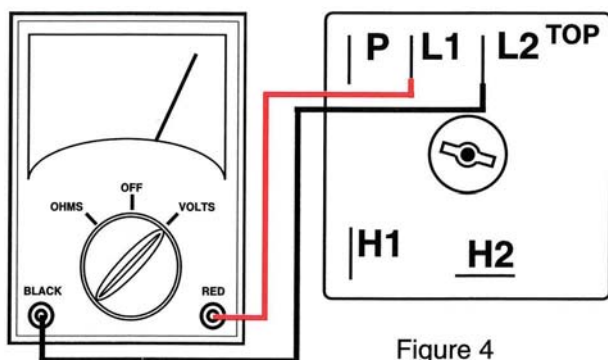

Infinite Switch Order Information

Consult the Uni-Line® catalog for additional specification and ordering information.

UNI-LINE ORDER NO.	VOLTAGE	% INPUT @ LO	DIAL INCLUDED	KIT TYPE	GENERAL APPLICATION
5500-102	120V	5%	NONE	NON PUSH-TO-TURN	UNI-KIT
5500-103	120V	5%	BLACK	NON PUSH-TO-TURN	UNI-KIT
5500-104	120V	5%	WHITE	NON PUSH-TO-TURN	UNI-KIT
5500-105	120V	5%	NONE	PUSH-TO-TURN	UNI-KIT
5500-106	120V	5%	WHITE	PUSH-TO-TURN	UNI-KIT
5500-107	120V	5%	BLACK	PUSH-TO-TURN	UNI-KIT
5500-113	120V	22%	NONE	NON PUSH-TO-TURN	UNI-KIT
5500-133	120V	5%	CHROME	COMMERCIAL	UNI-KIT
5500-134	120V	5%	BLACK	COMMERCIAL	UNI-KIT
5500-135	120V	5%	WHITE	COMMERCIAL	UNI-KIT
5500-136	120V	5%	NONE	COMMERCIAL	UNI-KIT
5500-211	120V	5%	NONE	PUSH-TO-TURN	GE/HOTPOINT
5500-228	120V	5%	NONE	PUSH-TO-TURN	FRIGIDAIRE
5500-208	208V	5%	BLACK	NON PUSH-TO-TURN	UNI-KIT
5500-200	240V	5%	NONE	PUSH-TO-TURN	UNI-KIT
5500-202	240V	5%	NONE	NON PUSH-TO-TURN	UNI-KIT
5500-203	240V	5%	BLACK	NON PUSH-TO-TURN	UNI-KIT
5500-204	240V	5%	WHITE	NON PUSH-TO-TURN	UNI-KIT
5500-206	240V	5%	WHITE	PUSH-TO-TURN	UNI-KIT
5500-207	240V	5%	BLACK	PUSH-TO-TURN	UNI-KIT
5500-212	240V	5%	NONE	PUSH-TO-TURN	GE/HOTPOINT
5500-213	240V	22%	NONE	NON PUSH-TO-TURN	UNI-KIT
5500-224	240V	5%	NONE	PUSH-TO-TURN	GE/HOTPOINT
5500-225	240V	5%	NONE	REVERSE-ROTATION	UNI-KIT
5500-229	240V	5%	NONE	PUSH-TO-TURN	FRIGIDAIRE
5500-234	240V	5%	BLACK	COMMERCIAL	UNI-KIT
5500-235	240V	5%	WHITE	COMMERCIAL	UNI-KIT
5500-236	240V	5%	NONE	COMMERCIAL	UNI-KIT
5500-237	240V	5%	NONE	NON PUSH-TO-TURN	WESTINGHOUSE
5500-287	240V	5%	NONE	PUSH-TO-TURN	WHIRLPOOL
5500-288	240V	5%	NONE	NON PUSH-TO-TURN	WHIRLPOOL
5500-289	240V	5%	NONE	PUSH-TO-TURN	WHIRLPOOL
5500-290	240V	5%	NONE	REVERSE-ROTATION	WHIRLPOOL
5500-299	240V	5%	NONE	PUSH-TO-TURN REVERSE-ROTATION	UNI-KIT
5500-512	240V	5%	NONE	PUSH-TO-TURN	GE WB21X5243

All Uni-Kits have a 1 ¹³/₁₆" square break off shaft.

Invensys.
Controls
191 E. North Avenue
Carol Stream, IL 60188
www.invensyscontrols.com
©2008 Invensys Controls

For Customer Service:
Telephone 1.800.304.6563
Facsimile 1.800.426.0804
HVACCustomerService@invensyscontrols.com

For Technical Service:
Telephone 1.800.445.8299
Facsimile 1.800.260.7242
technicalservice@invensys.com

Invensys®, Robertshaw® and Uni-Line® are trademarks of Invensys plc., its subsidiaries and/or affiliated companies. All other brands mentioned in this report may be the trademarks of their respective owners. 6/08 – 150-2160